

6 Easy Steps Towards Your Modern Edge Architecture with

Xentara

Specify Cycle Time In μ s And Xentara Will Maintain Real-Time

1

```
"@Track": {
  "id": "RealTime Cycle",
  "uuid": "76d2ec6e-7e38-",
  "threadCount": 1,
  "timers": [
    {
      "referenceTime": 0,
      "period": 100,
```

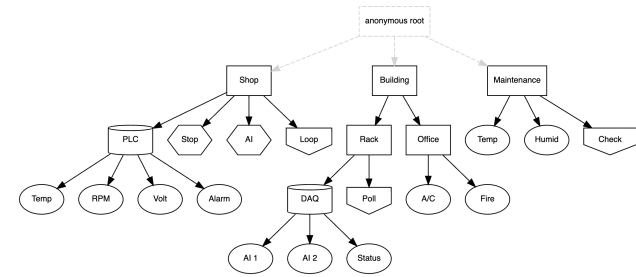

Connect Analytics & Train Artificial Intelligence/Machine Learning

4



Connect Your I/O And Other Hardware

2

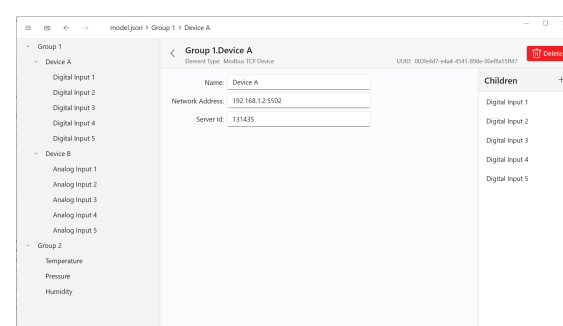

Add Additional Value & Converge With IT / Cloud

5

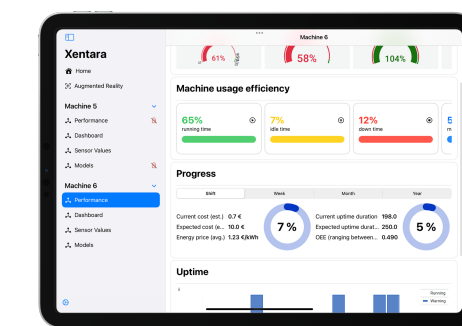
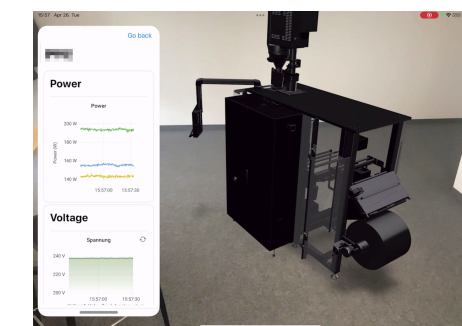
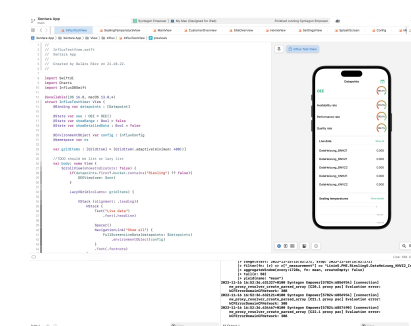

Build Or Import Your Control Logic & Design Your HMI

3

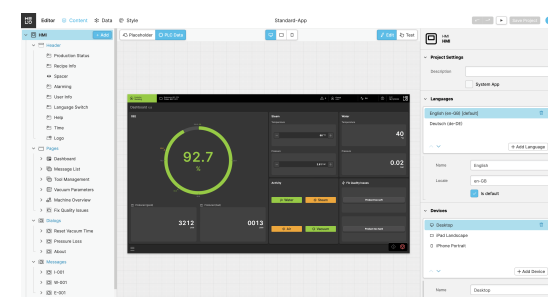
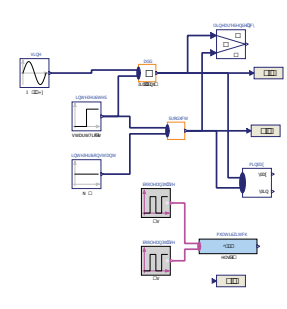
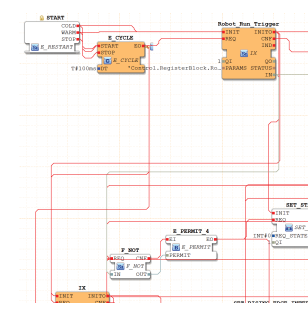

Deploy Your System On Any Hardware Or Software Platform

6

